



SOP Emulator



PMD Source/Emulator



PDL Source/Emulator

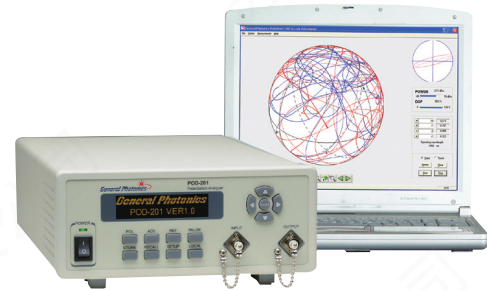

SOP Variation Monitoring

Instrumentation for Testing Polarization Performance of 400/800G Systems

Polarization is a critical issue for the successful deployment of high data rate coherent detection systems. Coherent receivers' polarization demultiplexing, PMD compensation, and PDL mitigation functions must be fully characterized as part of system development and testing.

Polarization impairment emulation and measurement instruments enable all polarization related tests, including:

- **PMD tolerance, tracking speed, and recovery time**
- **SOP tracking speed and recovery time**
- **PDL tolerance, tracking speed, and recovery time**

Polarization Impairment Test Setup

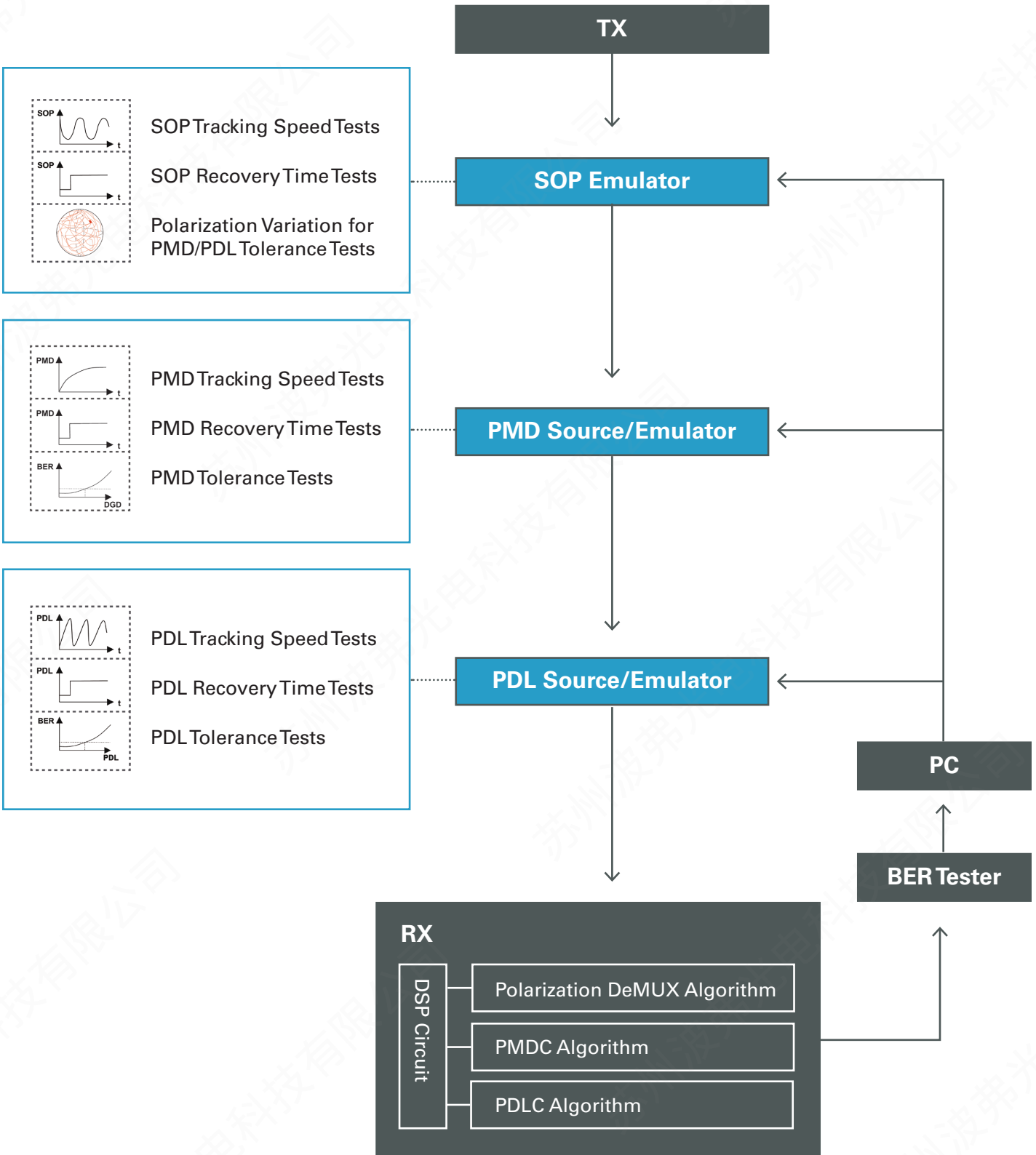

NRT-2500

Polarization Controller (High Speed)

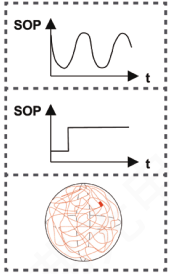

SOP Tracking Speed Tests

SOP Recovery Time Tests

Polarization Variation for PMD/PDL Tolerance Tests

Polarization Emulation Functions

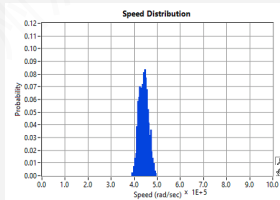
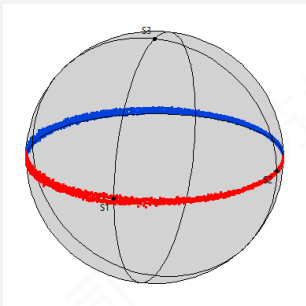

Polarization Spinner

For polarization tracking speed test of a system's polarization DeMux algorithm

- Constant rotation speed, adjustable up to 940 krad/s*
- Rotation axis can be drifted to cover all polarization states

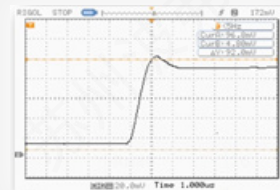
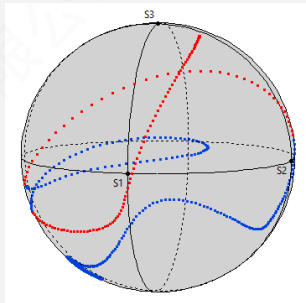

Randomizer

Generate fast Δ SOP impulses for recovery time tests or to emulate the effect of lightning strikes

- Slew rate ≤ 2.5 Mrad/s*
- SOP transitions can occur at a set rate or can be triggered

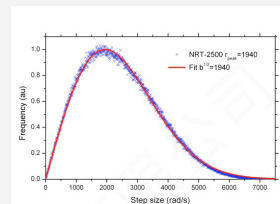
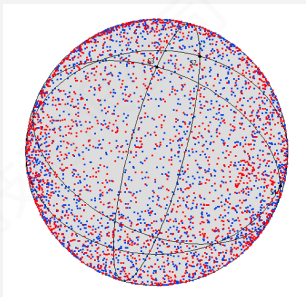

Scrambler

For emulating polarization fluctuation in real fiber systems

- The polarization variation rate follows a Rayleigh distribution (mean rate up to 25krad/s*)
- All polarization states are uniformly generated
- Use before PMD and PDL sources to test a system's PMD and PDL tolerances.

*SOP Rates are given in Stokes space, on the Poincaré Sphere

MPC-202/3

SOP Emulator (Wide Bandwidth, Low Loss)

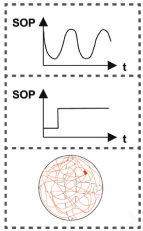

SOP Tracking Speed Tests

SOP Recovery Time Tests

Polarization Variation for PMD/PDL Tolerance Tests

Polarization Emulation Functions

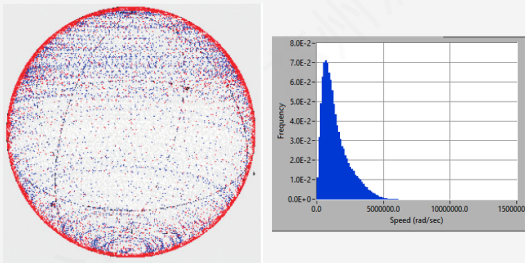

Tornado Scrambling

For polarization tracking speed test of a system's polarization DeMux algorithm

- All polarization states are uniformly generated
- Polarization variation rate can be up to 11 Mrad/s* (MPC-203)

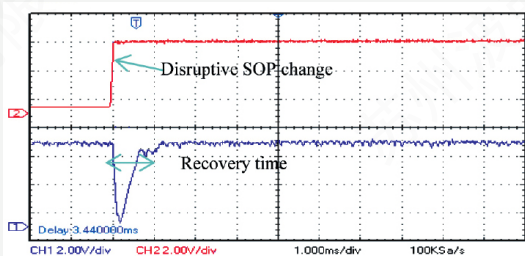

Square Wave Polarization Modulation

Generate fast polarization transitions between 2 SOPs to test a system's polarization recovery time

- Slew rate can be up to 360 krad/s* (MPC-202)
- SOP transitions can occur at a set rate or can be triggered

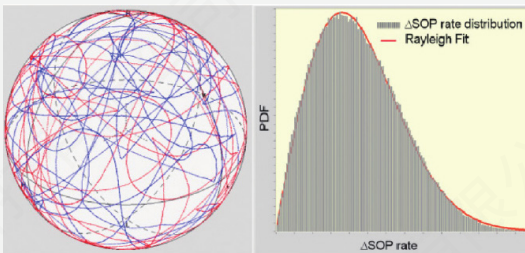

Rayleigh Scrambling

For emulating polarization fluctuation in real fiber systems

- The polarization variation rate follows a Rayleigh distribution; mean rate up to 2 krad/s*.
- All polarization states are uniformly generated
- Use before PMD and PDL sources to test a system's PMD and PDL tolerances.

*SOP Rates are given in Stokes space, on the Poincaré Sphere

PMD-1000

PMD Source/Emulator

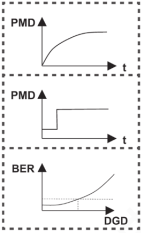

PMD Tracking Speed Tests

PMD Recovery Time Tests

PMD Tolerance Tests

Fastest PMD Generation with Greatest Flexibility

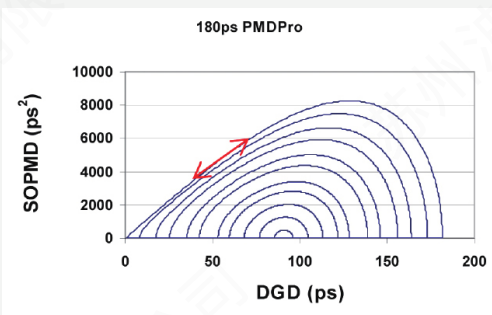
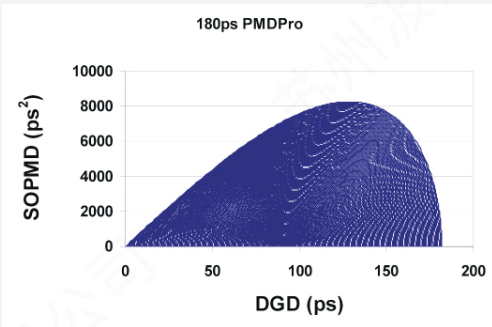

PMD Generation

Generates DGD and SOPMD for PMD tolerance test

- High speed: 1 ms per PMD state
- Wavelength independent PMD values: no free spectral range issues

PMD Scan

Generates smooth PMD scan traces along predetermined paths for PMD tracking speed test

- Programmable PMD variation speed
- User path selection

PMD Emulation

Generates statistical 1st and 2nd order PMD distributions occurring in real fibers

- Sorted PMD distribution
- Random PMD distribution

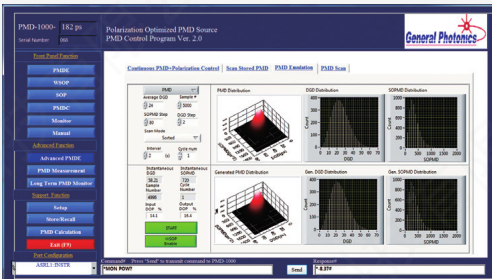

DGD-1000

DGD Source/Emulator

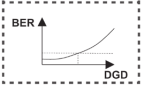

DGDTolerance Tests

Large DGD Range with High Stability

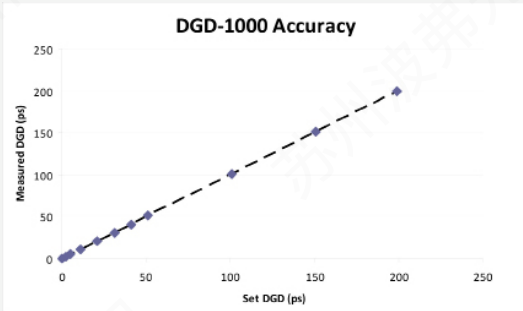

DGD Generation

Generates DGD for tolerance tests

- Range: Up to 400 ps
- Resolution: 0.2 ps
- Accuracy: $\pm(0.2+2\%$ of DGD) ps
- No second order PMD

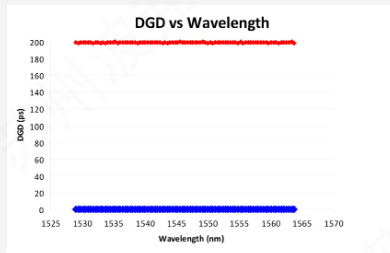
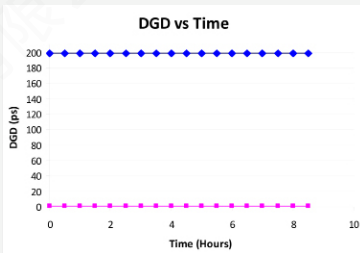

DGD Stability

- DGD is stable over time at any setting
- DGD is stable over wavelength at any setting

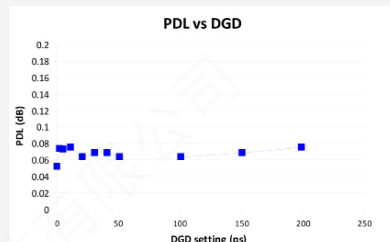
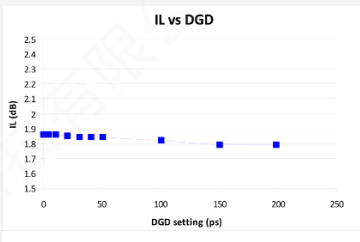

Loss Stability

- IL is stable over entire DGD range
- PDL is stable over entire DGD range

PDLE-101

PDL Source/Emulator

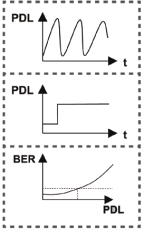

PDL Tracking Speed Tests

PDL Recovery Time Tests

PDL Tolerance Tests



The Only PDL Source/Emulator on the Market

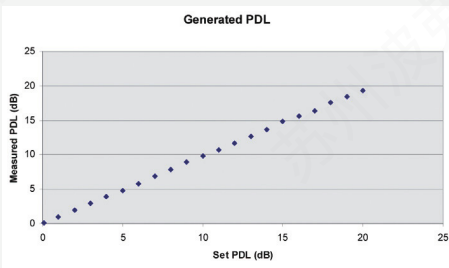

PDL Generation

Generates any PDL value from 0 to 20dB for PDL tolerance test

- Accuracy: $\pm (0.1 \text{ dB} + 1\% \text{ of PDL})$
- Speed: 1 ms typical

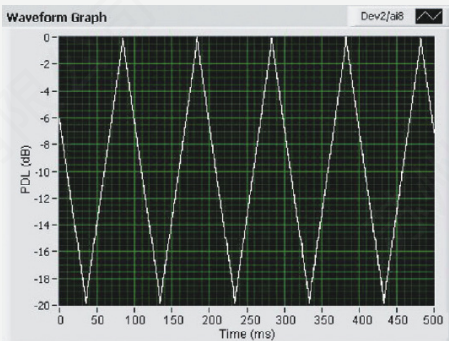

PDL Triangle Wave Generation

Generates PDL variations with predetermined speed for PDI tracking speed test

- PDL modulation frequency: up to 10 Hz
- PDL amplitude: 0 to 20 dB

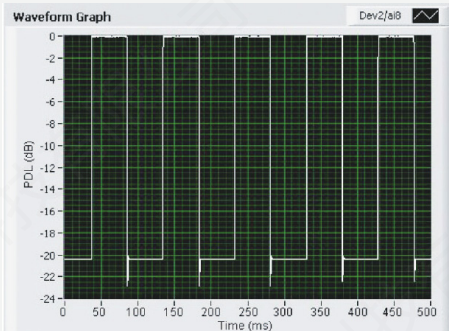

PDL Square Wave Modulation

Generates fast PDL transitions to test a system's PDL recovery time

- Slew rate can be up to 50,000 dB/s
- The transition can be triggered by a TTL pulse for synchronization

PSY-201

Polarization Synthesizer

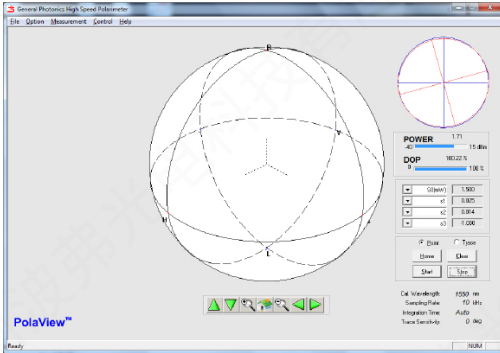

Polarization Locking

Locks polarization to any desired state, regardless of input polarization fluctuation.

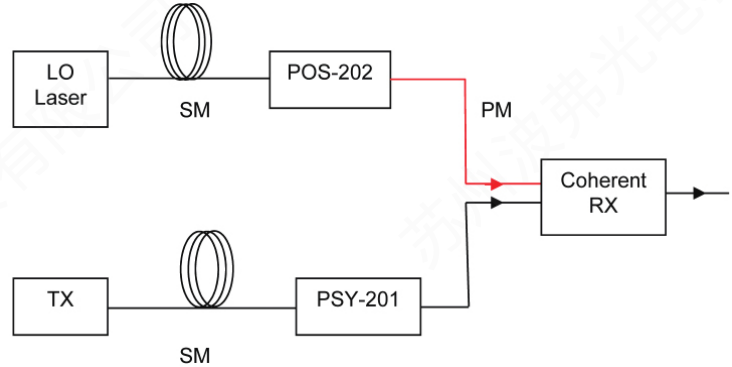

Coherent Receiver Polarization Sensitivity Test

Finds and locks to the best and worst polarization states, respectively, to test the corresponding receiver performances.

POD-201

Polarization Variation Monitor

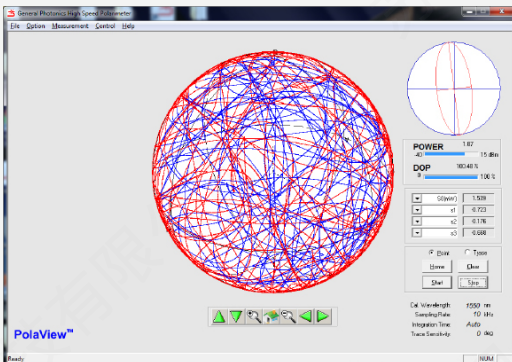
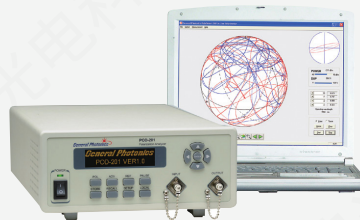

Polarization Traces on Poincaré Sphere

Measures and displays polarization variation traces while performing system polarization related tests.

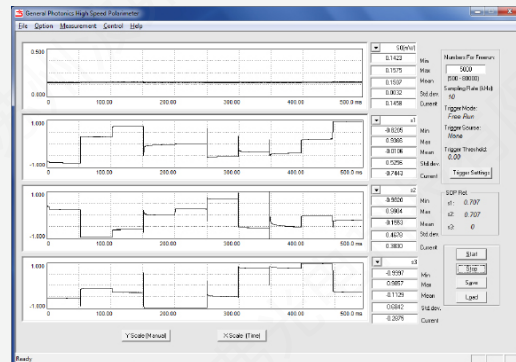

Polarization Changes in Oscilloscope Display

Measures and displays polarization rate of change on the oscilloscope window while performing system polarization related tests.